

# C063...R

# C080...R

## PHOENIX CAM SWITCHES WITH TYPE "R" PANEL MOUNTING (63 A / 80 A)

CODE READING .....	2
SPECIFICATIONS .....	3
OVERALL DIMENSIONS.....	6
ELECTRICAL SCHEMES.....	7
ACTUATORS .....	12
MOUNTING INSTRUCTIONS .....	13



Before use, read this booklet carefully to acquaint yourself with the features of the product. This booklet is an integral part of the product and therefore must be kept until the product is dismissed.



Giovenzana International B.V. reserves the right to change the features and data shown in this document at any time and without notice. This document cannot therefore be considered a contract with third parties.



C0 series cam switches are designed and manufactured according to IEC international standard and EN European regulations.



Any improper installation or any tampering of the device may cause serious personnel injury or property damage, therefore, the installation and maintenance must be performed by specialized and authorized personnel.



The use of this device is not allowed in environment with a potentially explosive atmosphere or in presence of corrosive substances and in salt spray.



**ATTENTION**

Before any installation or maintenance operation, disconnect the power supply to the system. Before restoring the power supply, make sure that all connections to the device have been made correctly. Giovenzana International B.V. disclaims any responsibility for any damage to things and people caused by non-compliance with the rules described here.

Cam switches involved in this instruction manual:

Series	Mounting	Terminal protection class	AC-21A (690 V)	AC-23A (400 V)
C063...R	Rear panel	IP00	63 A	40 A
C080...R			80 A	54 A

Read the page with the code reading for further useful information on the product in your possession. This instruction manual illustrates features and procedures relating to the products in the Giovenzana catalog. The specifications on p.3 and the mounting instructions on p.13, and following, are also valid for custom products derived from one of the series illustrated in this manual.

# CODE READING

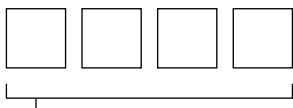

## Series

Specifications: p.3

**C063** 63 A, IP00 contacts

**C080** 80 A, IP00 contacts

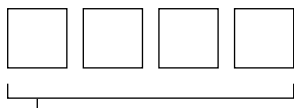

## Electrical scheme

Reference table: p.7

ON-OFF switches 0-1

**0001** 1 pole

**0002** 2 poles

**0003** 3 poles

**0004** 4 poles

**0005** 5 poles

**0006** 6 poles

Changeover switches 1-0-2

**0008** 1 pole

**0009** 2 poles

**0010** 3 poles

**0011** 4 poles

Motor switches

**0012** Reversing switch 3 poles

**0013** Reversing switch 3 poles with spring return to zero

**0014** Dahlander pole changing two speed switch

Step switches

**0025** Step switch 1-2 positions without zero 1 pole

**0026** Step switch 1-2 positions without zero 2 poles

**0027** Step switch 1-2 positions without zero 3 poles

**0038** Step switch 1-2-3 positions without zero 1 pole

**0039** Step switch 1-2-3 positions without zero 2 poles

**0040** Step switch 1-2-3 positions without zero 3 poles

**0028** Step switch 0-1-2 positions with zero 1 pole

**0032** Step switch 0-1-2 positions with zero 2 poles

**0033** Step switch 0-1-2 positions with zero 3 poles



## Cam switch mounting type

Overall dimensions: p.6

**R** rear panel mounting

**S** custom product (these products have their own electrical scheme, not available in this document)

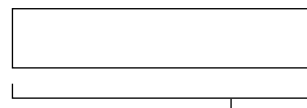

## Actuator code

Each cam switch series can be fitted with one or more actuators with their own code. This document provides the installation instructions for each cam switch series and its matching actuators.

Actuators reference table: p.17

# SPECIFICATIONS

## General characteristics

Protection class	control	EN 60529	IP65
	control with knob only		IP40
	terminals		IP00
Material group		EN 60947-1	II
Pollution grade		EN 60947-1	3
Flammability		UL94	V0 (live electrical parts)
Ambient temperature	operating		-40 ... +70°C
	storage		-40 ... +70°C
Climate withstand		IEC 68 part 2-3 IEC 68 part 2-30	damp heat, steady state damp heat, cyclic
Terminal screw identification	conforming to		EN50013
Connections	terminal block caliber	EN60947-1	A7
	terminal screw		2 × M4
	tightening torque	EN60947-1 UL508	1.2 N·m (10.6 lb·in) 10.62 lb·in (1.2 N·m)
Connectable section	flexible conductors		2.5 ... 35 mm <sup>2</sup> AWG 14 ... 3
	solid conductors		2.5 ... 35 mm <sup>2</sup> AWG 14 ... 3
Contacts			double breaking
Opening angles			45° - 60° - 90°
Mechanical lifetime	@ 120 operations / hour		1 million cycles
Electrical lifetime	@ 120 operations / hour		C063... 0.5 million cycles C080... 0.25 million cycles

## EN 60947-3 characteristics

		C063...	C080...
Rated operating voltage	U <sub>e</sub>	690 V	690 V
Rated insulation voltage	U <sub>i</sub>	690 V	690 V
Rated impulse withstand voltage (sectionable)	U <sub>imp</sub>	8 kV	8 kV
Rated thermal current	I <sub>th</sub>	85 A	100 A
Rated enclosed thermal current	I <sub>the</sub>	85 A	100 A
Frequency		50/60 Hz	50/60 Hz

## Alternate current

Rated operating current		$I_e$		C063...		C080...		
AC-21A	Switching of resistive loads, including moderate overloads		690 V		63 A		80 A	
AC-22A	Switching of mixed resistive and inductive loads, including moderate overloads		690 V		63 A		80 A	
AC-23A	Switching of motor loads or other highly inductive loads	1 phase - 1 pole	110 V		45 A	4 kW	63 A	5.5 kW
			230 V		45 A	7.5 kW	63 A	11 kW
		3 phases - 3 poles	230 V		50 A	15 kW	58 A	18.5 kW
			400 V		40 A	22 kW	54 A	30 kW
			500 V		40 A	30 kW	54 A	37 kW
		690 V		32 A	30 kW	40 A	37 kW	
AC-3	Squirrel-cage motors: starting, switches off motors during running time	1 phase - 1 pole	110 V		36 A	3.7 kW	45 A	4 kW
			230 V		36 A	6.5 kW	45 A	7.5 kW
		3 phases - 3 poles	230 V		37 A	11 kW	47 A	15 kW
			400 V		35 A	18.5 kW	44 A	22 kW
			500 V		35 A	22 kW	44 A	30 kW
		690 V		25 A	22 kW	32 A	30 kW	
AC-23A	Nominal breaking capacity ( $\cos\phi$ 0.45)		230 V		400 A		464 A	
			400 V		320 A		432 A	
			500 V		320 A		432 A	
			690 V		256 A		320 A	



## Short circuit characteristics

		C063...	C080...
Rated short-time short circuit withstand current (1 s) $I_{cw}$		1200 A	1200 A
Rated short circuit making capacity	$I_{cm}$	2000 A	2000 A
Conditional rated short circuit withstand current		10 kA	10 kA
Fuse rating (type gG)	690 V	100 A	100 A

## UL 508 characteristics

			C063...	C080...
General use	600 V AC		63 A	85 A
Standard motor load	1 phase - 2 poles	120 V AC	5 HP	56 FLA
		240 V AC	7.5 HP	40 FLA
	3 phases - 3 poles	240 V AC	15 HP	42 FLA
		480 V AC	30 HP	40 FLA
		600 V AC	40 HP	41 FLA
			20 HP	54 FLA
			40 HP	52 FLA
			50 HP	52 FLA

## Marking

Compliance by passed test	Approved
	 

# OVERALL DIMENSIONS

C063...R / C080...R

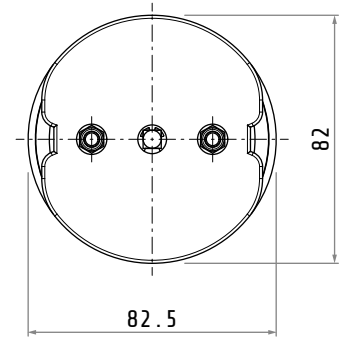
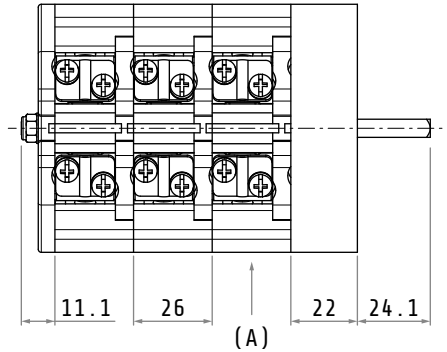
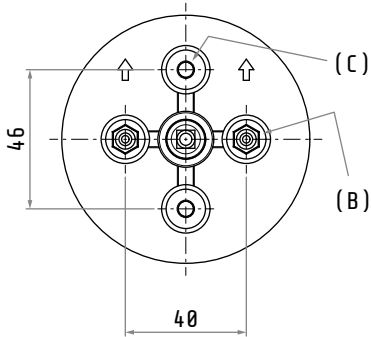

Terminal  
protection class  
IP00

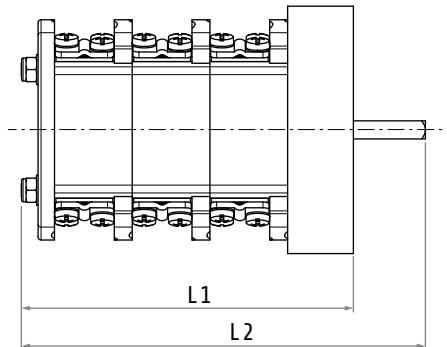

Dimensions in mm  
Illustrations NOT in scale

- (A) wafer (thickness = 26 mm)
- (B) metric screw (M5) fixing hole
- (C) metric screw (M5) fixing hole

Some dimensions depend on the number of wafers of the cam switch and can be calculated with these formulas:

$$L1 \text{ [mm]} = 11.1 + (26 \times \text{n. of wafers}) + 22$$

$$L2 \text{ [mm]} = L1 + 24.1$$

Examples:

n. of wafers	1	2	3	4	5	6
L1 [mm]	59.1	85.1	111.1	137.1	163.1	189.1
L2 [mm]	83.2	109.2	135.2	161.2	187.2	213.2

# ELECTRICAL SCHEMES

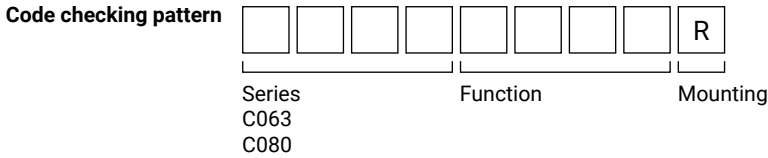

Function	N. of wafers	Electrical scheme
ON-OFF switches 0-1		
0001 ON-OFF switch 1 pole	1	p.8
0002 ON-OFF switch 2 poles	1	
0003 ON-OFF switch 3 poles	2	
0004 ON-OFF switch 4 poles	2	
0005 ON-OFF switch 5 poles	3	
0006 ON-OFF switch 6 poles	3	
Changeover switches 1-0-2		
0008 Changeover switch 1 pole	1	p.8
0009 Changeover switch 2 poles	2	
0010 Changeover switch 3 poles	3	
0011 Changeover switch 4 poles	4	
Motor switches		
0012 Reversing switch 3 poles	3	p.9
0013 Reversing switch 3 poles with spring return to zero	3	
0014 Dahlander pole changing two speed switch	4	
Step switches		
0025 Step switch 1-2 positions without zero 1 pole	1	p.10
0026 Step switch 1-2 positions without zero 2 poles	2	
0027 Step switch 1-2 positions without zero 3 poles	3	
0038 Step switch 1-2-3 positions without zero 1 pole	2	
0039 Step switch 1-2-3 positions without zero 2 poles	3	
0040 Step switch 1-2-3 positions without zero 3 poles	5	
0028 Step switch 0-1-2 positions with zero 1 pole	1	
0032 Step switch 0-1-2 positions with zero 2 poles	2	
0033 Step switch 0-1-2 positions with zero 3 poles	3	

## ON-OFF switches 0-1

0001 • 1 pole

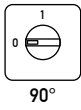

1				
	1-2			x
<b>W</b>	<b>CNT</b>	0		1

0002 • 2 poles



1	3-4			x
	1-2			x
<b>W</b>	<b>CNT</b>	0		1

0003 • 3 poles

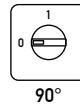

2				
	5-6			x
1	3-4			x
	1-2			x
<b>W</b>	<b>CNT</b>	0		1

0004 • 4 poles

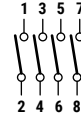
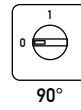

2	7-8			x
	5-6			x
1	3-4			x
	1-2			x
<b>W</b>	<b>CNT</b>	0		1

0005 • 5 poles

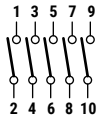
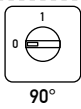

3				
	9-10			x
2	7-8			x
	5-6			x
1	3-4			x
	1-2			x
<b>W</b>	<b>CNT</b>	0		1

0006 • 6 poles

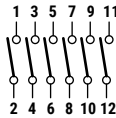
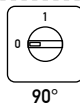

3	11-12			x
	9-10			x
2	7-8			x
	5-6			x
1	3-4			x
	1-2			x
<b>W</b>	<b>CNT</b>	0		1

## Changeover switches 1-0-2

0008 • 1 pole

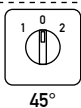

1	3-4			x
	1-2	x		
<b>W</b>	<b>CNT</b>	1	0	2

0009 • 2 poles

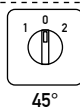

2	7-8			x
	5-6	x		
1	3-4			x
	1-2	x		
<b>W</b>	<b>CNT</b>	1	0	2

0010 • 3 poles

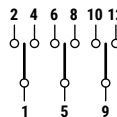
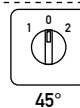

3	11-12			x
	9-10	x		
2	7-8			x
	5-6	x		
1	3-4			x
	1-2	x		
<b>W</b>	<b>CNT</b>	1	0	2

0011 • 4 poles

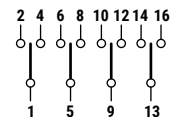
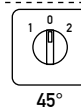

4	15-16			x
	13-14	x		
3	11-12			x
	9-10	x		
2	7-8			x
	5-6	x		
1	3-4			x
	1-2	x		
<b>W</b>	<b>CNT</b>	1	0	2



# Motor switches

**0012** • Reversing switch 3 poles

**0013** • Reversing switch 3 poles with spring return to zero

**0014** • Dahlander pole changing two speed switch

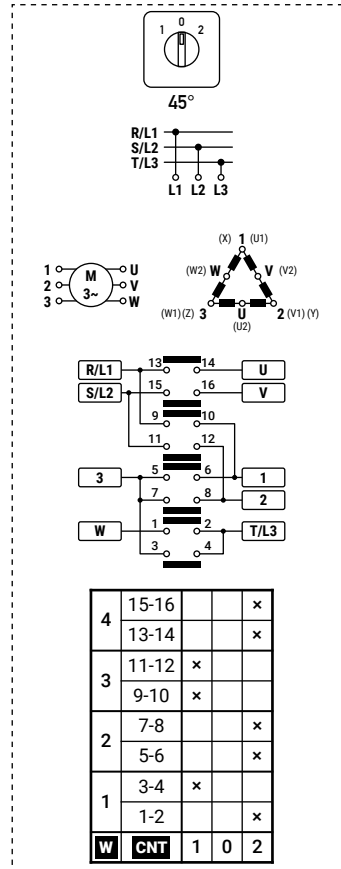
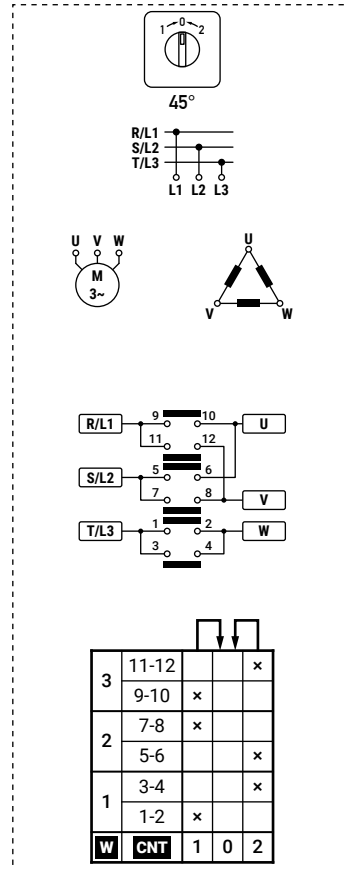
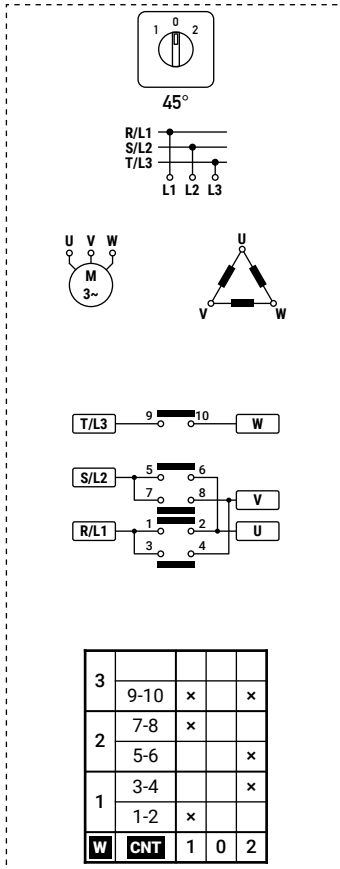

# Step switches

1/2

**0025** • Step switch 1-2 positions without zero 1 pole

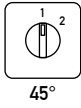

1	3-4		x
	1-2	x	
<b>W</b>	<b>CNT</b>	1	2

**0026** • Step switch 1-2 positions without zero 2 poles

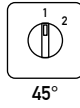

2	7-8		x
	5-6	x	
1	3-4		x
	1-2	x	
<b>W</b>	<b>CNT</b>	1	2

**0027** • Step switch 1-2 positions without zero 3 poles

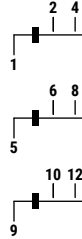
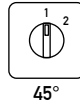

3	11-12		x
	9-10	x	
2	7-8		x
	5-6	x	
1	3-4		x
	1-2	x	
<b>W</b>	<b>CNT</b>	1	2

**0038** • Step switch 1-2-3 positions without zero 1 pole

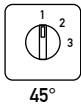

2	5-6			x
1	3-4		x	
	1-2	x		
<b>W</b>	<b>CNT</b>	1	2	3

**0039** • Step switch 1-2-3 positions without zero 2 poles

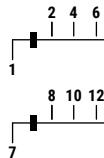
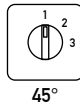

3	11-12			x
	9-10		x	
2	7-8	x		
	5-6			x
1	3-4		x	
	1-2	x		
<b>W</b>	<b>CNT</b>	1	2	3

**0040** • Step switch 1-2-3 positions without zero 3 poles

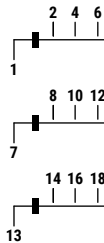
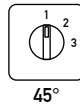

5	17-18			x
4	15-16		x	
	13-14	x		
3	11-12			x
	9-10		x	
2	7-8	x		
	5-6			x
1	3-4		x	
	1-2	x		
<b>W</b>	<b>CNT</b>	1	2	3

## Step switches

2/2

**0028** • Step switch 0-1-2 positions with zero 1 pole

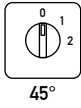

1	3-4		x
	1-2	x	
<b>W</b>	<b>CNT</b>	0	1 2

**0032** • Step switch 0-1-2 positions with zero 2 poles

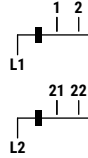
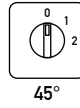

2	7-8		x
	5-6	x	
1	3-4		x
	1-2	x	
<b>W</b>	<b>CNT</b>	0	1 2

**0033** • Step switch 0-1-2 positions with zero 3 poles

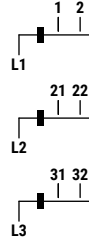
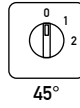



3	11-12		x
	9-10	x	
2	7-8		x
	5-6	x	
1	3-4		x
	1-2	x	
<b>W</b>	<b>CNT</b>	0	1 2

# ACTUATORS











## Cam switches / actuators matrix

Check the "Operation schemes matrix" (p.12) to identify the available operation scheme for each operator. Each actuator is referenced to the relevant page of the mounting instructions.

Series and size		C063 C080
Terminal protection class		IP00
Mounting type		R
<b>88×88</b>	Grey/Black	
screw	IP65	201/... (p.13)
<b>92×92</b>	Grey/Black max 3 padlocks	
screw	IP65	209/... (p.14)
<b>92×92</b>	Yellow/Red max 3 padlocks	
screw	IP65	210/... (p.14)

## Operation schemes matrix

Actuator code example: 201/0001

	ON-OFF switches 0-1			Changeover switches 1-0-2 / Motor switches	Step switches			
								
	90°	90°	45°	45°	45°	45°	45°	45°
 201/...	0001	0001-1	-	0008	0025	0028	0038	0029
 209/...	0001	0001-1	-	0008	-	-	-	-
 210/...	0001	0001-1	-	0008	-	-	-	-

# MOUNTING INSTRUCTIONS

201/...

screw fixing

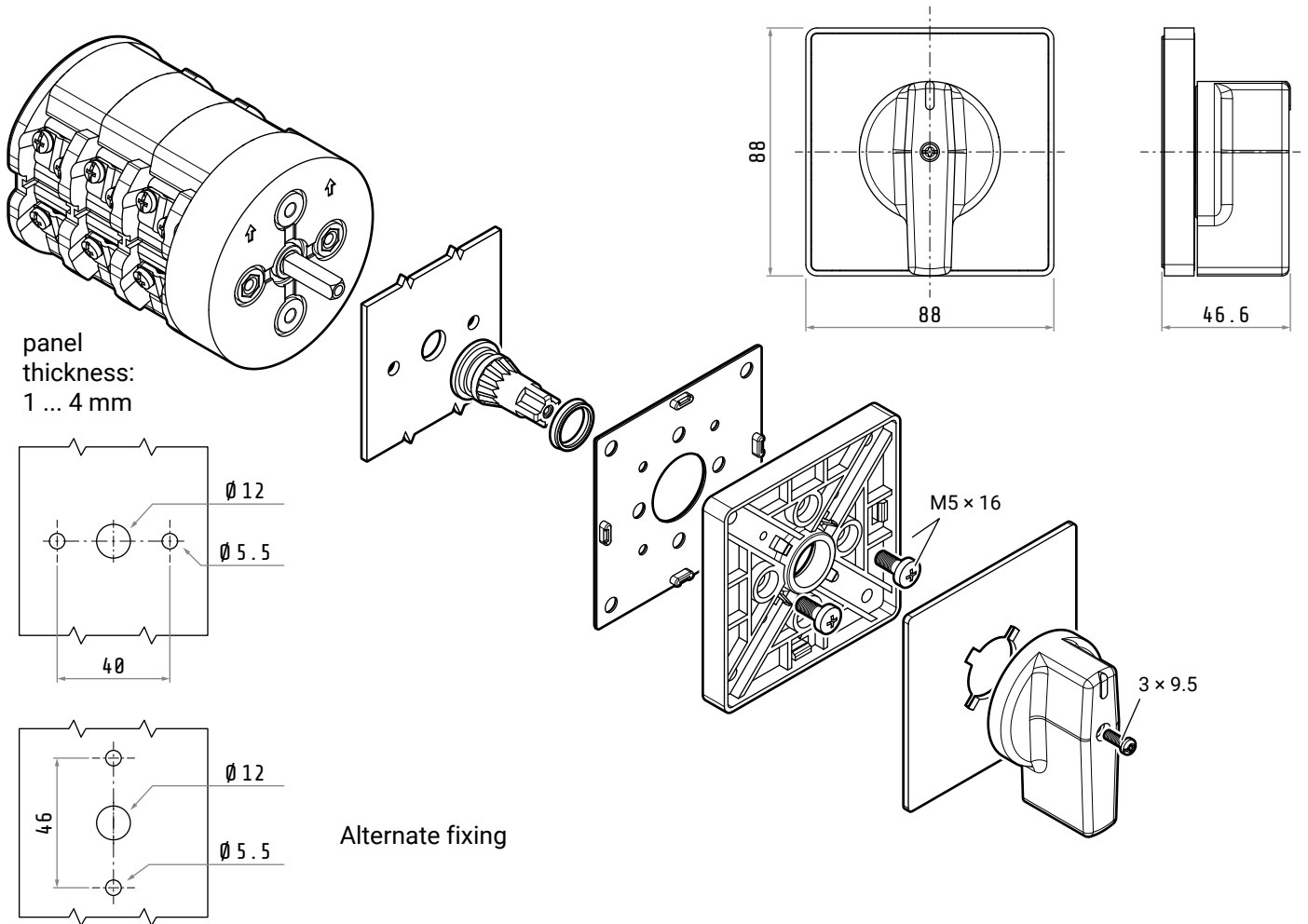

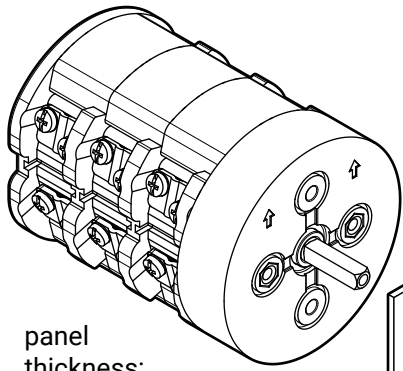

panel  
thickness:  
1 ... 4 mm

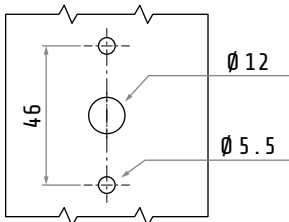
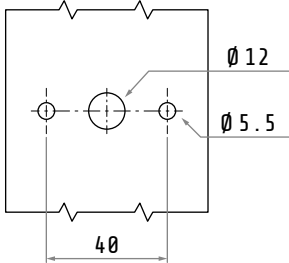

Alternate fixing

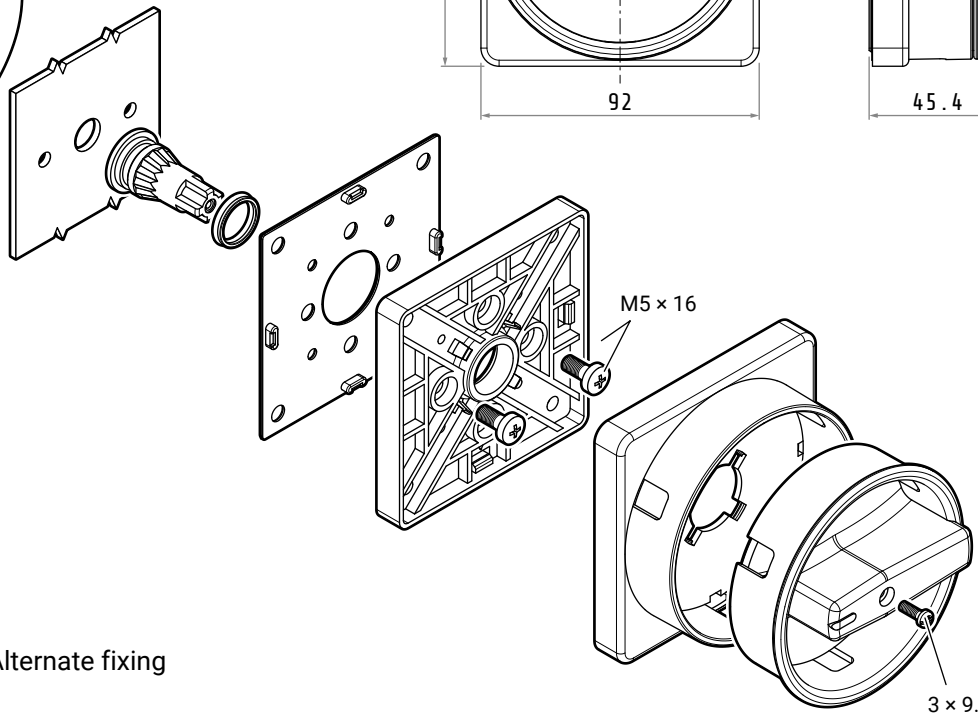
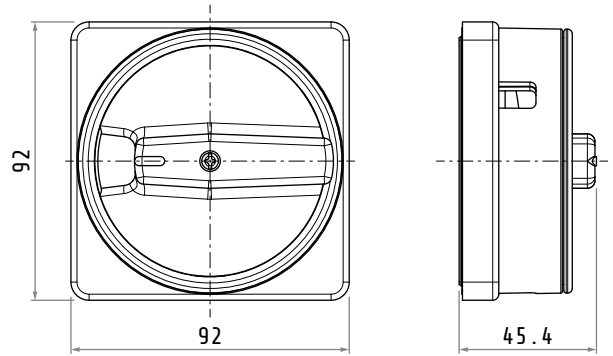

Padlocking is possible  
only in OFF position



up to 3 padlocks  
shackle: 8 mm max



A series of horizontal dashed lines spanning the width of the page, providing a template for text entry.

