

HP

PENDANT STATION



Before use, read this booklet carefully to acquaint yourself with the features of the product. This booklet is an integral part of the product and therefore must be kept until the product is dismissed.



Giovenzana International B.V. reserves the right to change the features and data shown in this document at any time and without notice. This document cannot therefore be considered a contract with third parties.



HP pendant stations are designed and manufactured according to IEC international standard and EN European regulations.



Improper installation or tampering can cause serious damage to people and property, therefore installation and maintenance must be carried out by specialized and authorized personnel.



The device is not intended for use in environments with a potentially explosive atmosphere or in the presence of corrosive substances and in salt fog.



Ergonomic pendant stations for small hoist:

- Bi-directional, mechanically interlocked
- IP65 double insulation IEC / EN 60529
- Laser engraved symbols comply with EN 60204-1, FEM 9.941
- Shock proof and heat resistant
- Single speed or two speed motor
- Direct motor control 1 kW - 1 speed
- HP03 and HP05 available in UL/CSA requirements
- Contact blocks with spring terminals

IMPORTANT INFORMATION 2

TECHNICAL CHARACTERISTICS 3

VERSIONS 5

WIRING 8

IMPORTANT INFORMATION

THE INFORMATION SHOWN ON THIS PAGE IS ESSENTIAL FOR THE CORRECT INTERPRETATION OF WHAT HAS BEEN EXPOSED IN THIS BOOKLET.

Symbols

The following symbols are used in this booklet:



Read carefully before use.



Information note.



ATTENTION, the information highlighted by this symbol is very important.



DANGER, the information highlighted by this symbol concerns environments with a potentially explosive atmosphere or the presence of corrosive substances and salt fog.



This symbol highlights the recommended tightening torques to guarantee the degree of protection of the product and to prevent it from breaking.

ATTENTION
IT IS DANGEROUS TO OPERATE THE PUSH-BUTTONS AT THE SAME TIME

Contact block with spring terminals

Insert the flathead screwdriver into the opening (a) and turn it half a turn. Insert the end of the cable into the opening (b) and remove the screwdriver to lock the end of the cable. In detail, the mechanical action of the screwdriver on (c) opens (d) and allows to insert the end of the cable.

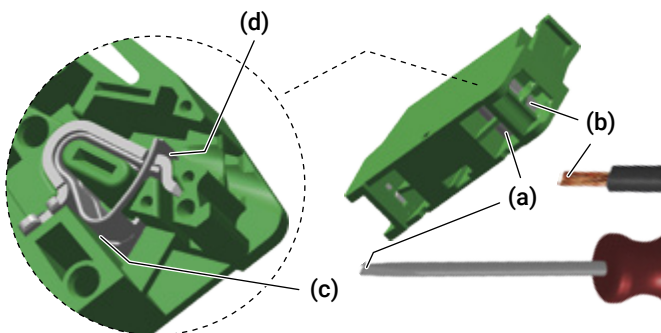

ATTENTION Connectable section to the contact blocks			
flexible conductors	1 or 2	0.5 ... 2.5 mm ² 18 ... 12 AWG	
solid conductors	1 or 2	0.5 ... 2.5 mm ² 18 ... 12 AWG	
wire peeling length		8 mm	

Tools required (not supplied)



Phillips screwdriver



Flathead screwdriver



Scissors



Wrench 33 mm



PCF key (to be purchased separately)



Torque screwdriver with its flat and Phillips heads

TECHNICAL CHARACTERISTICS

Pendant station technical data

Compliant to standards		IEC / EN60947-5-1
Material		ABS V0
Material group		II
Pollution class		3
Temperature	operating	-25°C ... +70°C
	storage	-30°C ... +70°C
Protection class		IP65
Cable entry	HP03...	spiral cable gland M20
	HP05... - HP07...	cable gland M25
	HP08...	cable gland M32
Weight	HP03...	330 g
	HP05...	450 g
	HP07...	620 g
	HP08...	720 g

Marking



Versions

- HP03 - HP03.D2
- HP05 - HP05.D2 - HP05.D4
- HP07 - HP07.D2 - HP07.D4 - HP07.D6
- HP08 - HP08.D2 - HP08.D4 - HP08.D6



Valid for HP03 and HP05 models only

Only for use with Type S or SJ cord rated 600 V, 75°C min.

Overcurrent protection shall be provided and sized per the following table:

Conductor AWG	Max Protection Ampacity
18	3.5
16	5.0
14	7.5
12	10

The maximum configuration for **HP03** shall be as following:

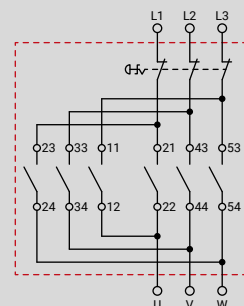

The maximum configuration for **HP05** shall be as following:

- No more than two buttons can be actuated simultaneously.
- No more than two NO contact block per operator.

Dimensions

Dimensions in mm
Drawing NOT in scale

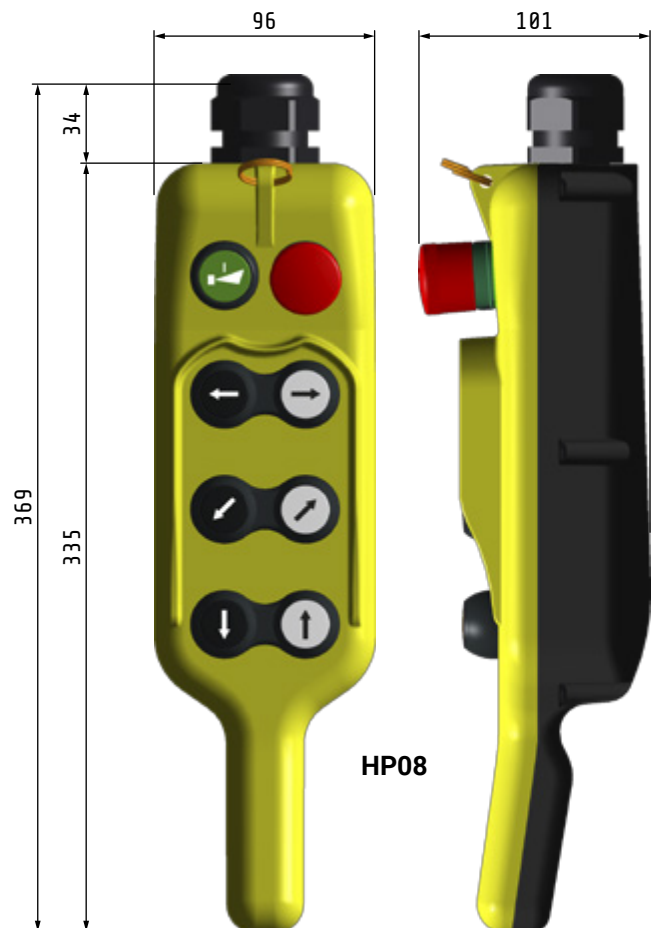
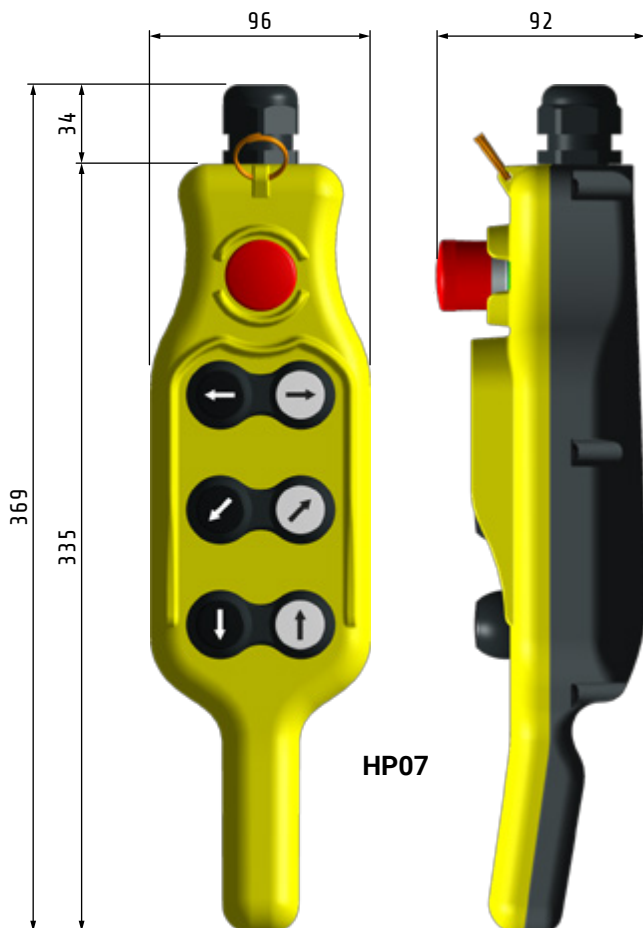
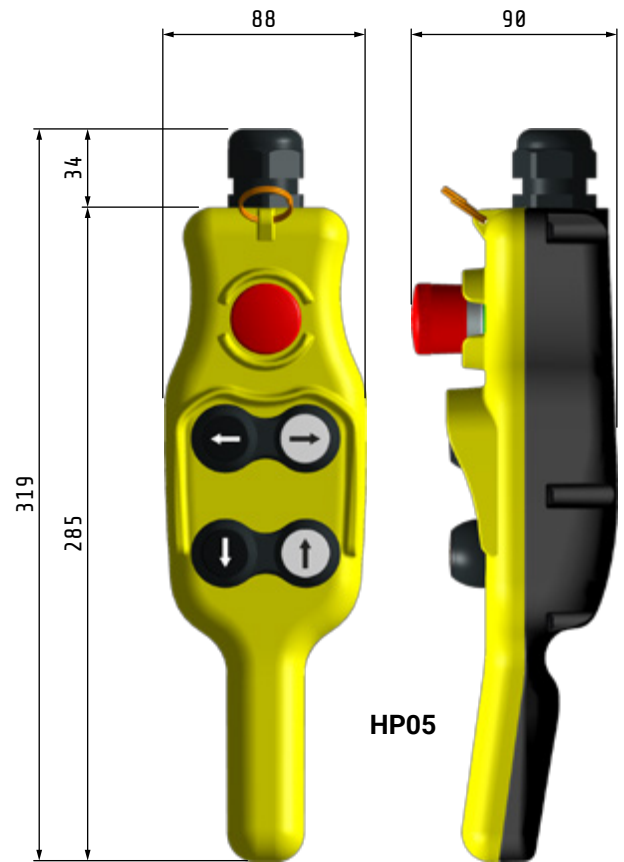
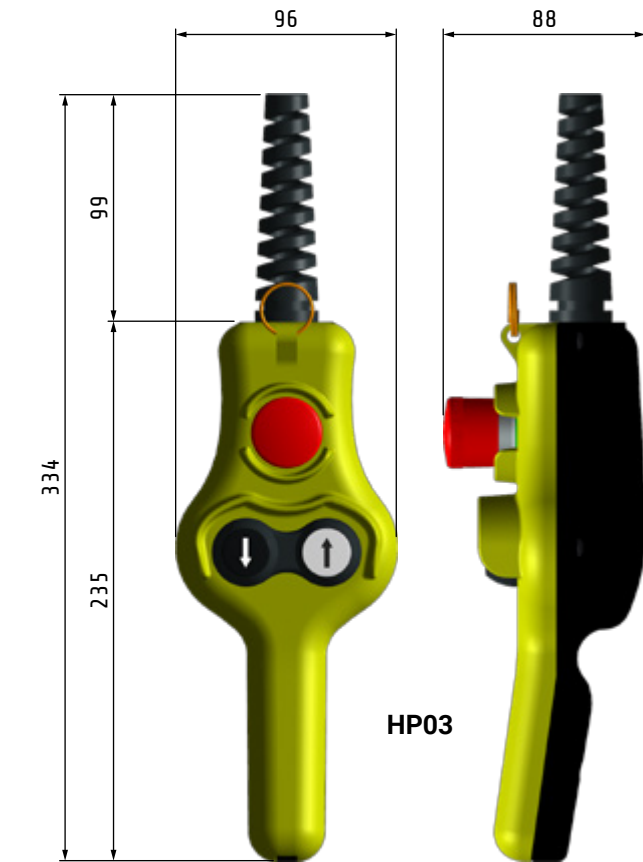

VERSIONS

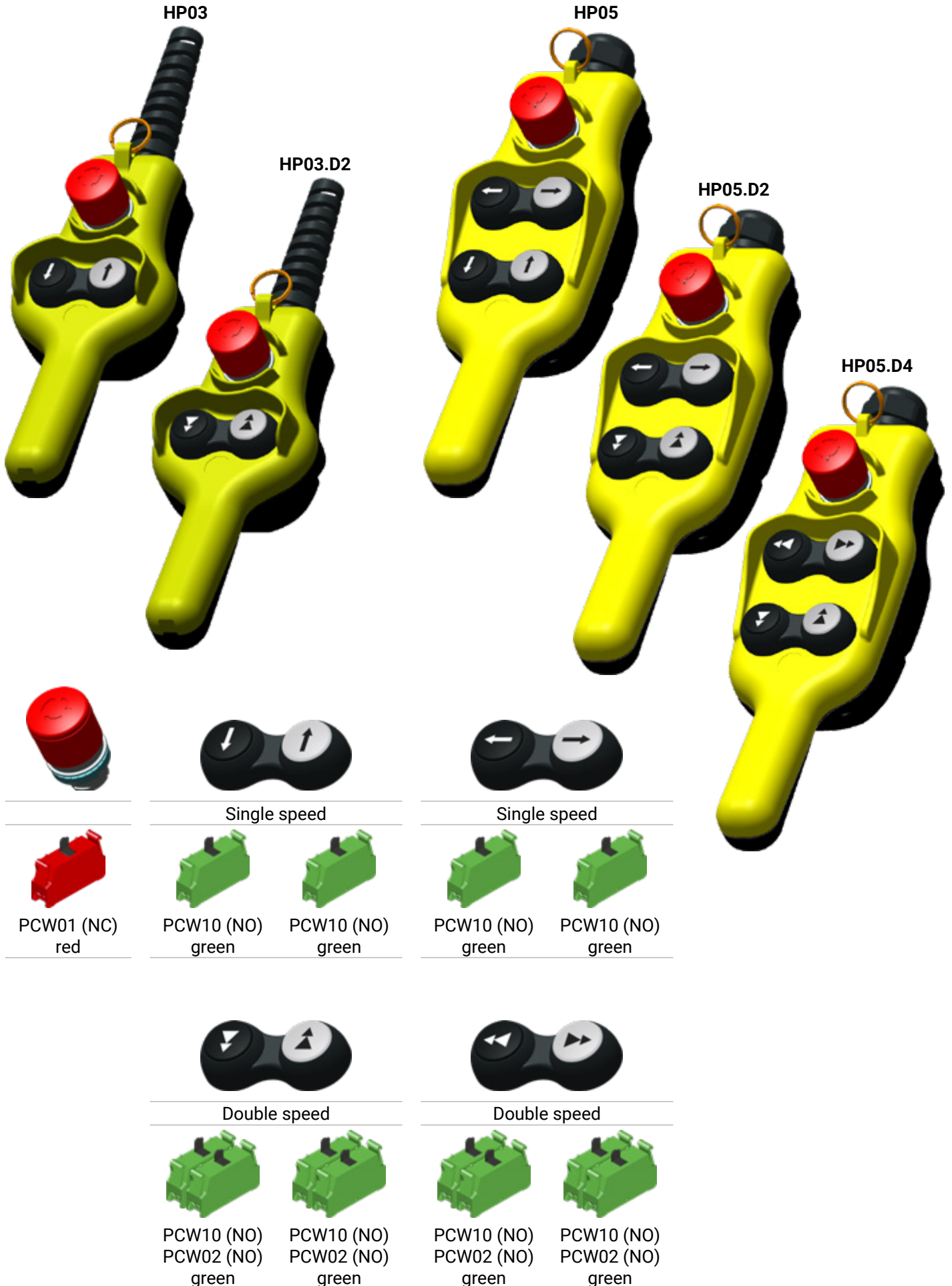



HP07

HP07.D2

HP07.D4

HP07.D6

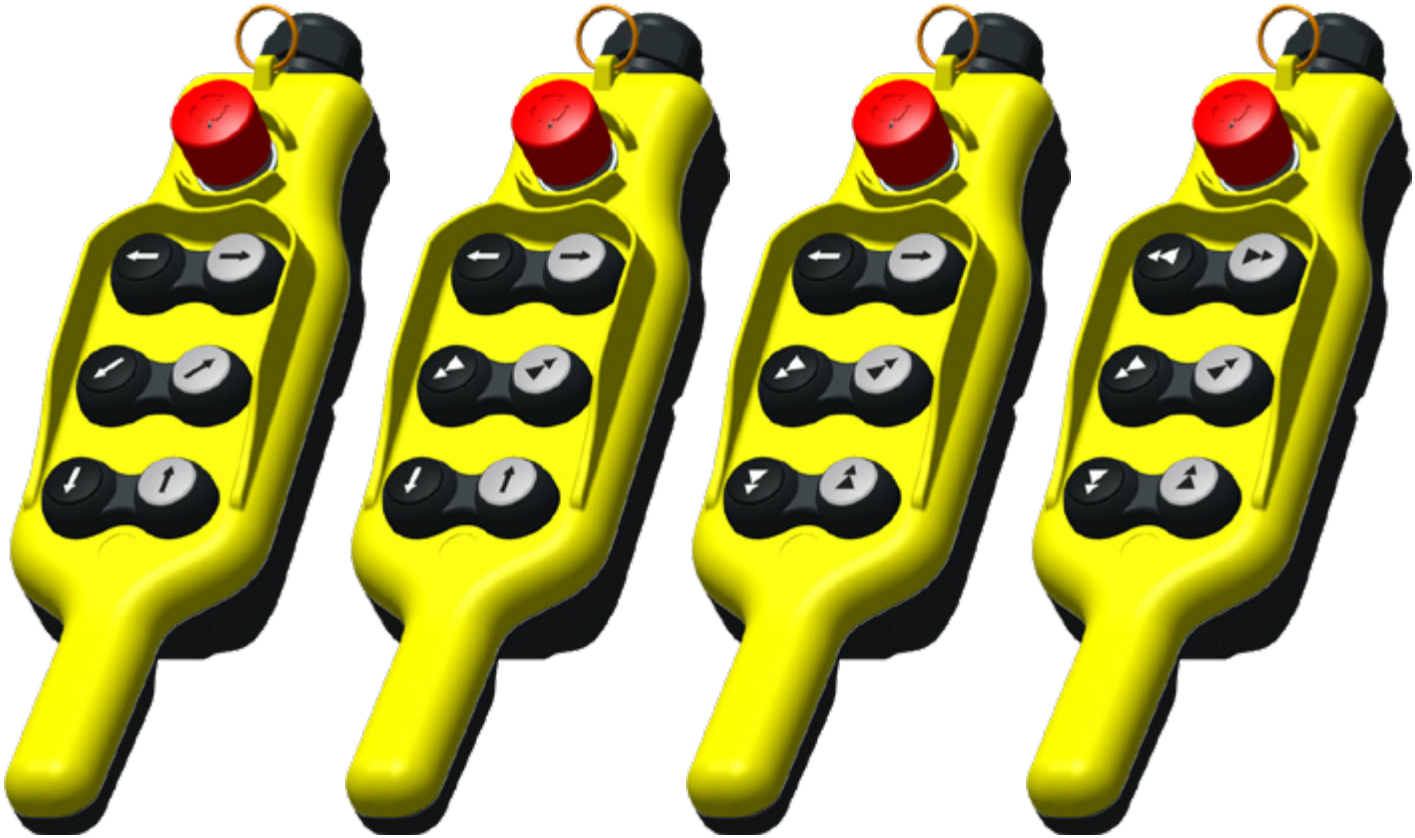

Single speed

Single speed

Single speed



PCW01 (NC)
red



PCW10 (NO)
green



PCW10 (NO)
green



PCW10 (NO)
green



PCW10 (NO)
green



PCW10 (NO)
green



PCW10 (NO)
green



Double speed



Double speed



Double speed



PCW10 (NO)
PCW02 (NO)
green



PCW10 (NO)
PCW02 (NO)
green



PCW10 (NO)
PCW02 (NO)
green



PCW10 (NO)
PCW02 (NO)
green



PCW10 (NO)
PCW02 (NO)
green



PCW10 (NO)
PCW02 (NO)
green



HP08

HP08.D2

HP08.D4

HP08.D6

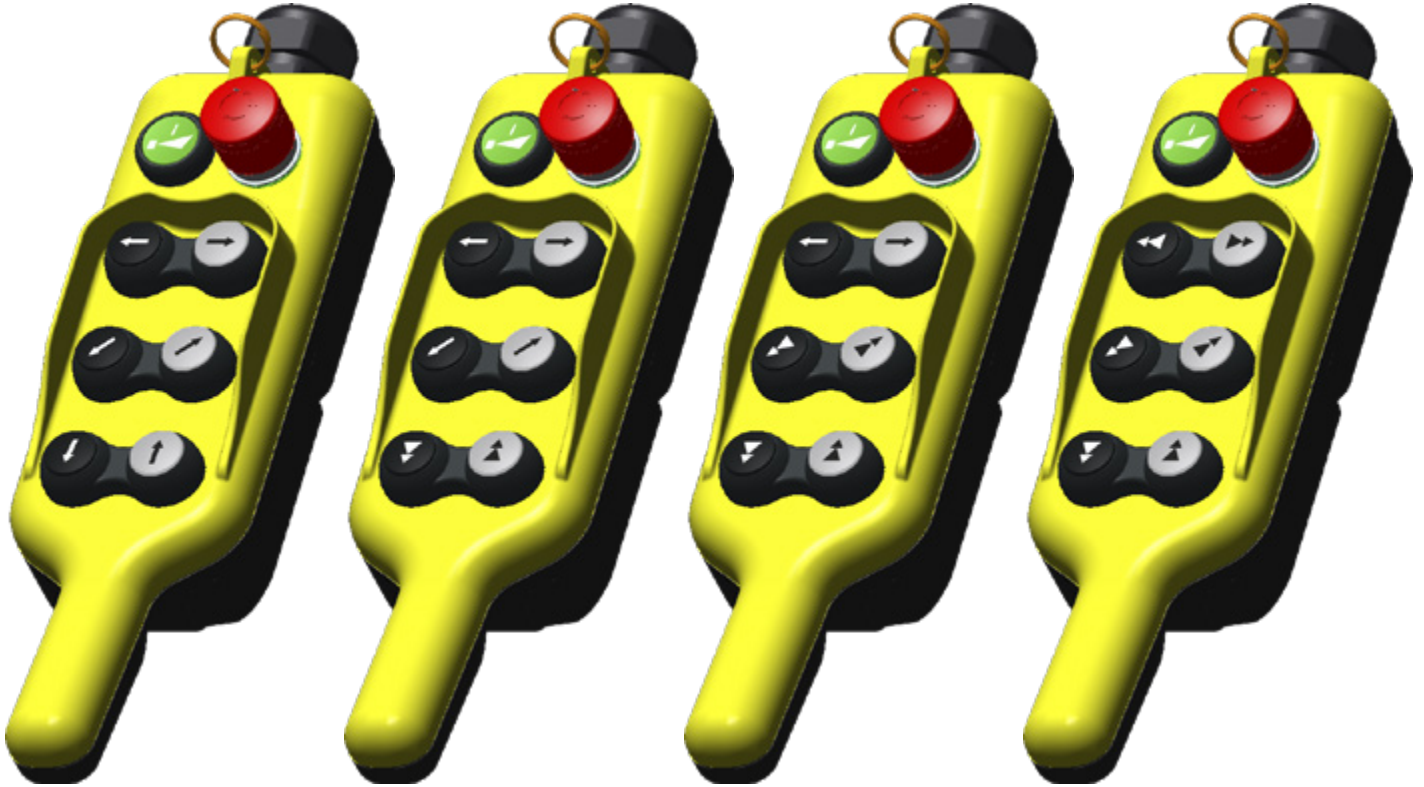

Single speed

Single speed

Single speed



PCW01 (NC)
red



PCW10 (NO)
green



PCW10 (NO)
green



PCW10 (NO)
green



PCW10 (NO)
green



PCW10 (NO)
green



PCW10 (NO)
green



Double speed



Double speed



Double speed



PCW10 (NO)
PCW10 (NO)
green



PCW10 (NO)
PCW02 (NO)
green



PCW10 (NO)
PCW02 (NO)
green



PCW10 (NO)
PCW02 (NO)
green



PCW10 (NO)
PCW02 (NO)
green



PCW10 (NO)
PCW02 (NO)
green



PCW10 (NO)
PCW02 (NO)
green

WIRING

HP03...

- 1 Loosen the screws to remove the bottom of the pendant station.

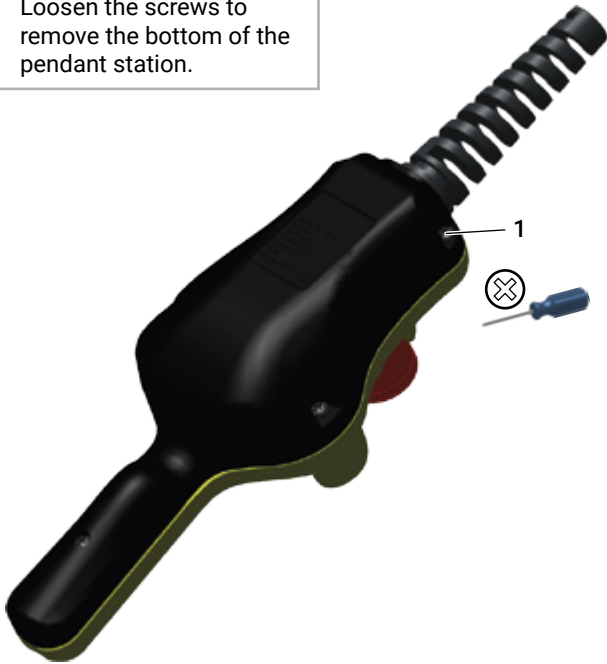

ATTENTION
Is shown the wiring of a push-button panel with only one contact element per key. The procedure is identical for 2 or 3 contact elements per key.

- 2 Loosen the screws of the cable holder and insert the cable into the cable clamp.

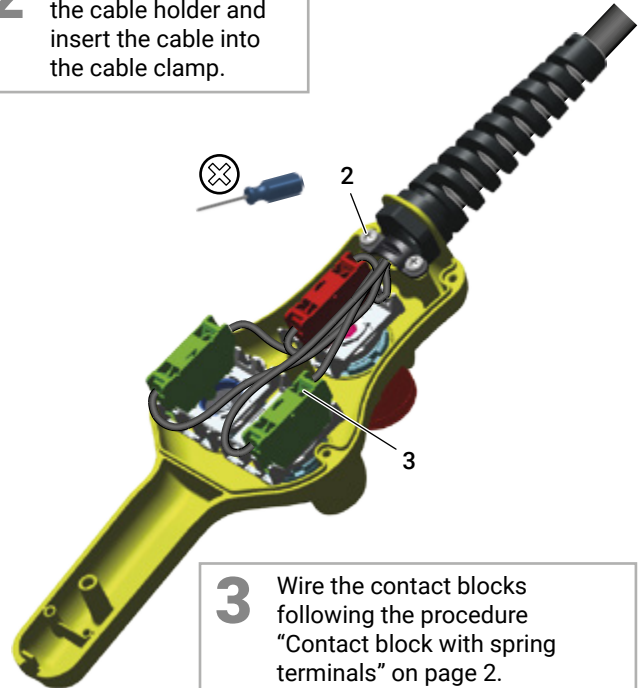

- 3 Wire the contact blocks following the procedure "Contact block with spring terminals" on page 2.

ATTENTION
The sections that can be connected to the contact blocks are shown in the paragraph "Contact block with spring terminals" on page 2.

- 4 Tighten the cable holder screws.

TIGHTENING TORQUE
1.2-1.4 N×m
10.6-12.4 lb×in

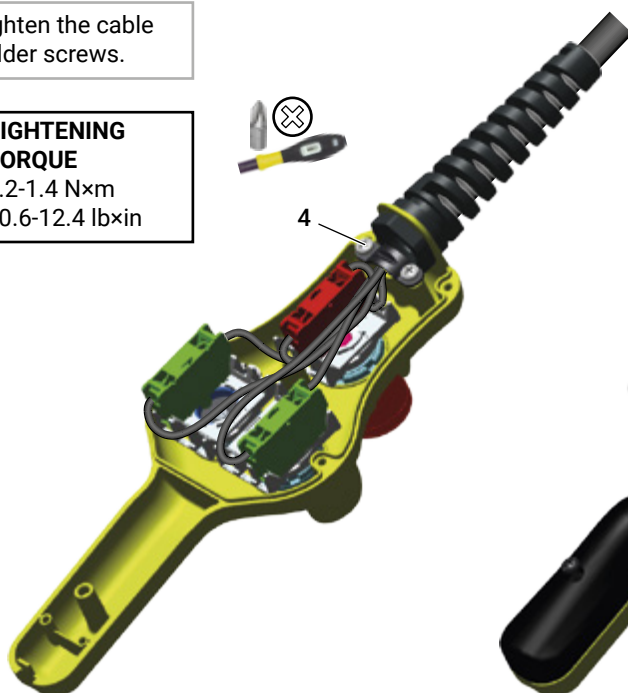

- 5 Replace the bottom of the pendant station and screw it in place.

TIGHTENING TORQUE
0.8-1.0 N×m
7-8.8 lb×in

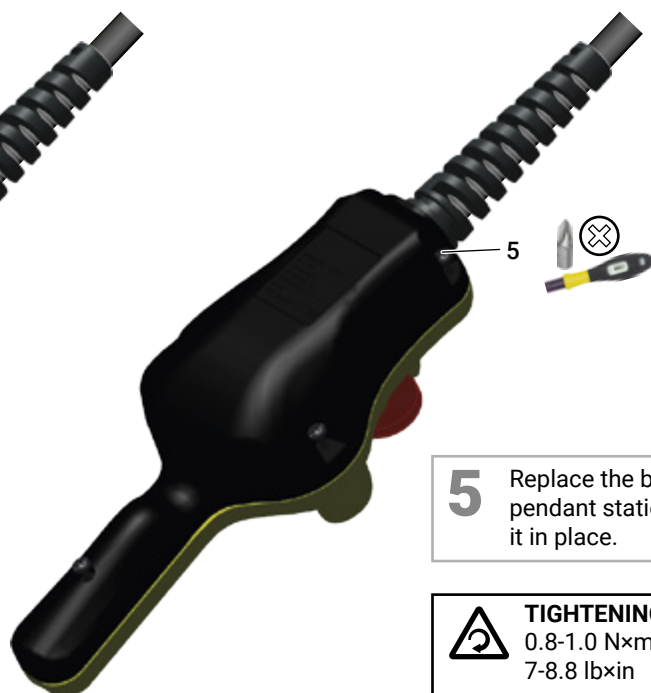

HP05... - HP07...

- 1** Loosen the screws to remove the bottom of the pendant station.

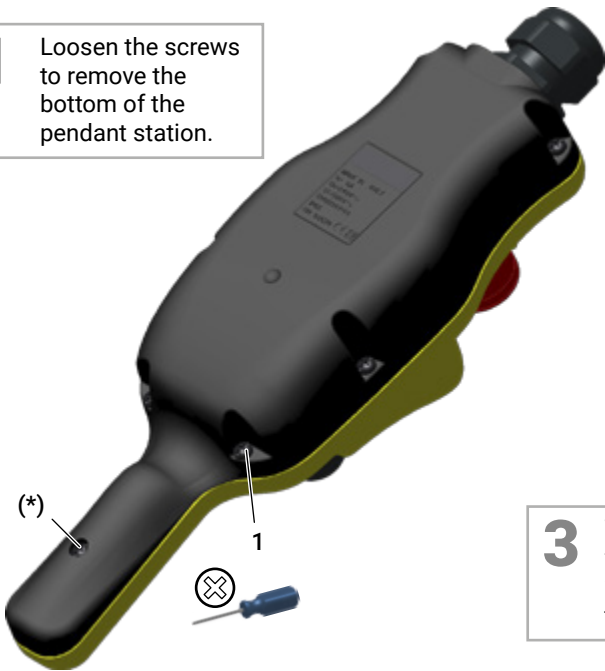

⚠ ATTENTION
The HP05 pendant station is used in the illustrations: the operations are the same for the HP07 pendant station and variants.

- 2** Loosen the screws of the cable holder and insert the cable into the cable clamp.

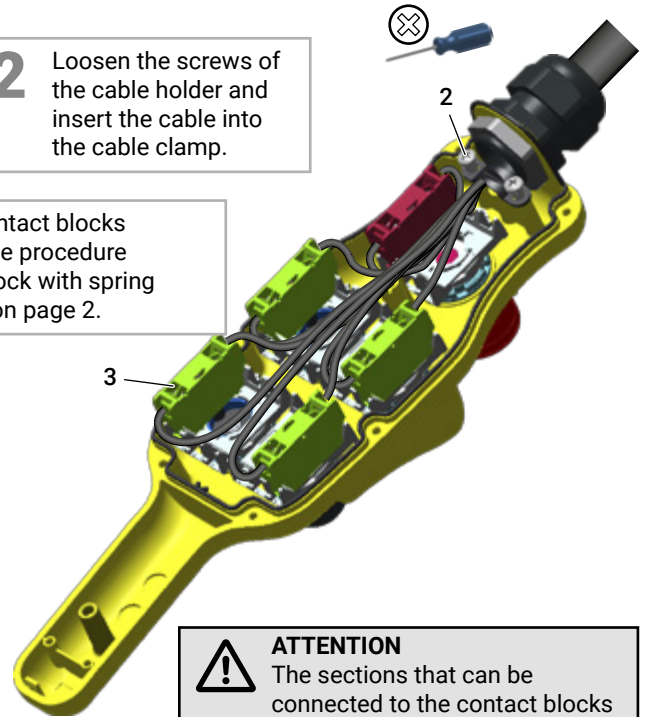

- 3** Wire the contact blocks following the procedure "Contact block with spring terminals" on page 2.

⚠ ATTENTION
The screw (*) may not be present on some pendant stations.

- 4** Tighten the cable holder screws.

⚙ TIGHTENING TORQUE
1.2-1.4 Nxm
10.6-12.4 lbxin

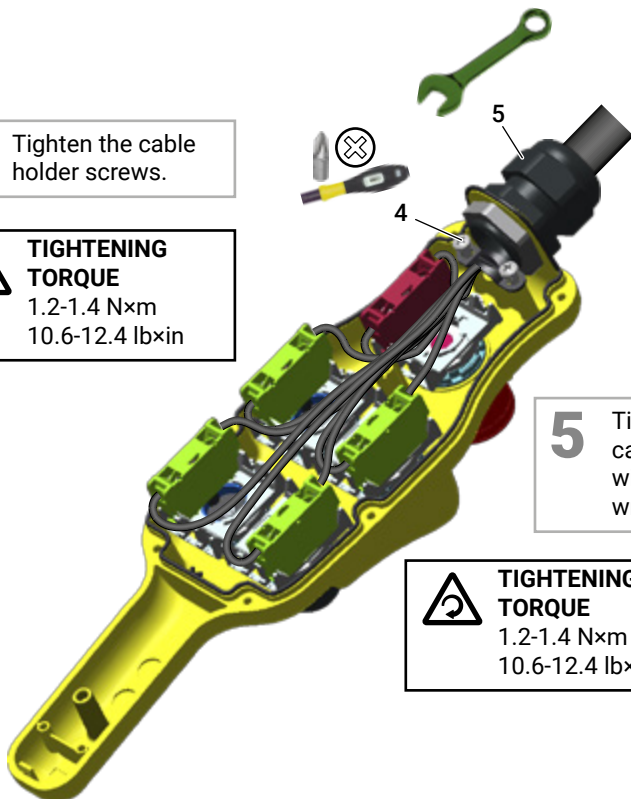

⚠ ATTENTION
The sections that can be connected to the contact blocks are shown in the paragraph "Contact block with spring terminals" on page 2.

- 5** Tighten the cable clamp with a 33 mm wrench.

⚙ TIGHTENING TORQUE
1.2-1.4 Nxm
10.6-12.4 lbxin

- 6** Replace the bottom of the pendant station and screw it in place.

⚙ TIGHTENING TORQUE
0.8-1.0 Nxm
7-8.8 lbxin

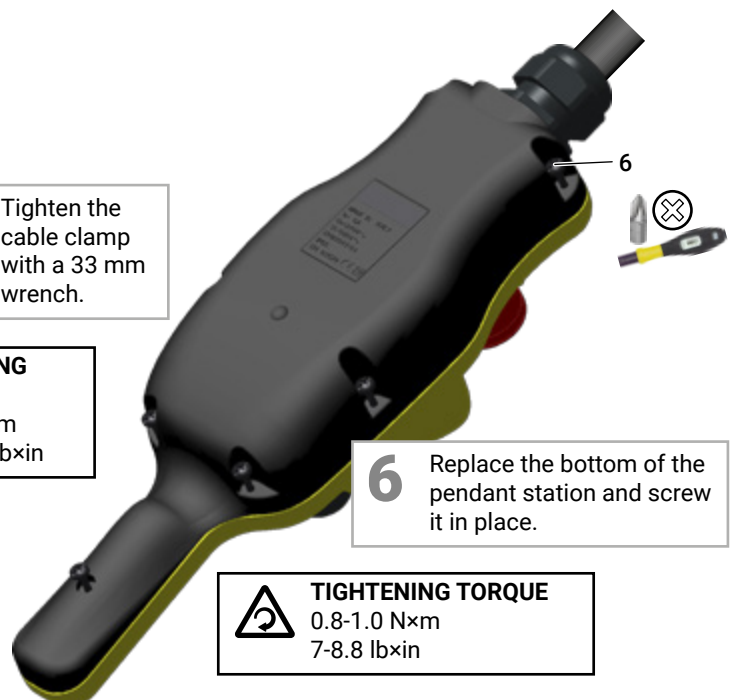

HP08...

- 1** Loosen the screws to remove the bottom of the pendant station.



⚠ ATTENTION
The HP05 pendant station is used in the illustrations: the operations are the same for the HP07 pendant station and variants.

- 2** Loosen the screws of the cable holder and insert the cable into the cable clamp.

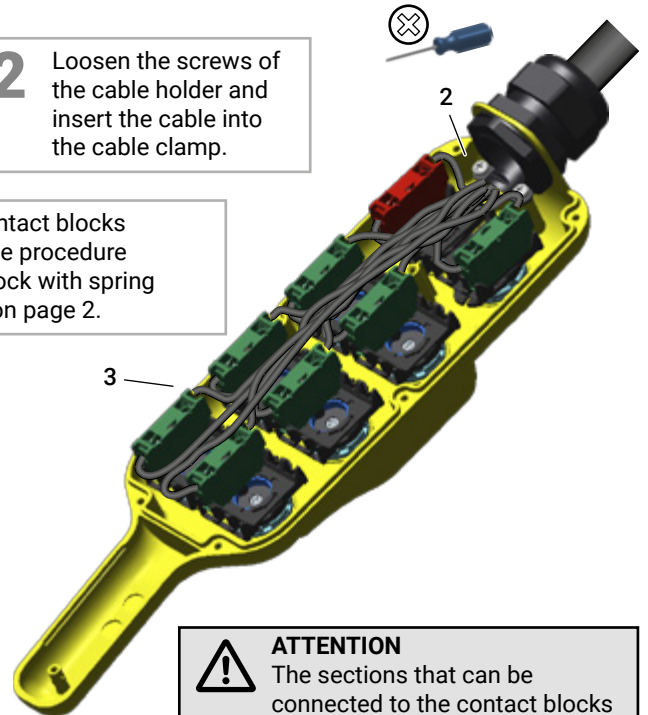

- 3** Wire the contact blocks following the procedure "Contact block with spring terminals" on page 2.

⚠ ATTENTION
The screw (*) may not be present on some pendant stations.

- 4** Tighten the cable holder screws.

⚙ TIGHTENING TORQUE
1.2-1.4 Nxm
10.6-12.4 lbxin

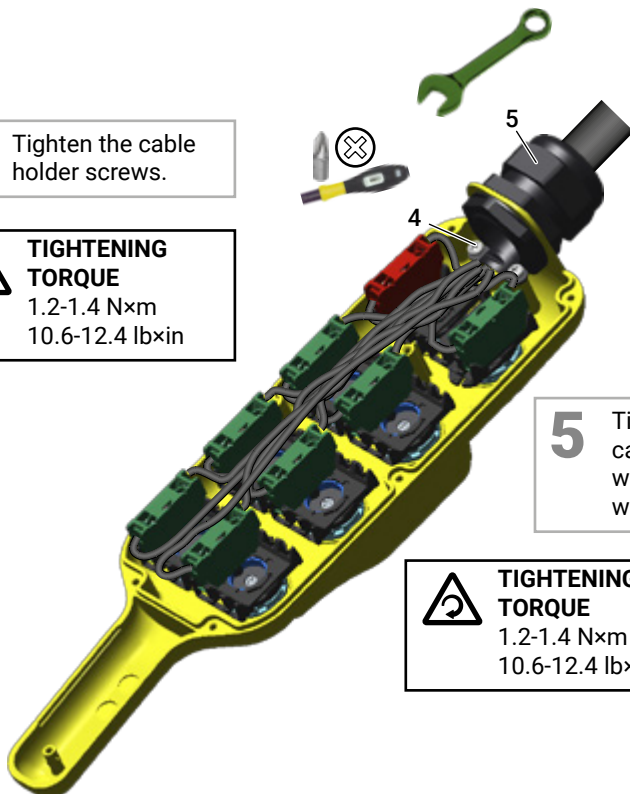

- 5** Tighten the cable clamp with a 33 mm wrench.

⚙ TIGHTENING TORQUE
1.2-1.4 Nxm
10.6-12.4 lbxin

⚠ ATTENTION
The sections that can be connected to the contact blocks are shown in the paragraph "Contact block with spring terminals" on page 2.

- 6** Replace the bottom of the pendant station and screw it in place.

⚙ TIGHTENING TORQUE
0.8-1.0 Nxm
7-8.8 lbxin

